



CDi 2302

Stud Welding Unit

92-10-2302B



Operating Manual



After-sales service for Germany:

**HBS Bolzenschweiss-Systeme GmbH & Co. KG
Felix-Wankel-Strasse 18
85221 DACHAU
GERMANY**

**Phone +49 8131 511-0
Fax +49 8131 511-100
E-mail international@hbs-info.com
Web www.hbs-info.com**

CDi 2302 Operating Manual Issue 2018-01 Order No. E-BA 92-10-2302B

Translation of the Original Operating Manual

Please keep the manual in a safe place for future reference.

Transmission and duplication of this document, dissemination and notification of the contents are not permitted unless expressly approved.

All rights, errors and technical amendments reserved.

© HBS Bolzenschweiss-Systeme GmbH & Co. KG



Dear Customer,

Many thanks for buying a stud welding machine from HBS Bolzenschweiss-Systeme.

We at HBS wish you success at all times when working with this stud welding machine.

The high level of quality of our products is guaranteed by ongoing further development in the design, equipment and accessories. This may result in differences between the present operating manual and your product. No claims can therefore be derived from the data, illustrations and descriptions.

We have compiled the data and information in this reference work with the greatest care, and have made every effort to ensure that the information contained in this manual was correct and up-to-date at the time of delivery. We can nevertheless give no guarantee for an absolutely error-free document.

Should you discover any errors or unclear points when reading this operating manual, please do not hesitate to contact us.

We would also be grateful for any feedback should you have any suggestions or complaints to make about our product.

HBS Bolzenschweiss-Systeme GmbH & Co. KG

Felix-Wankel-Strasse 18

85221 Dachau

GERMANY



Table of Contents

1	Important Safety Precautions	6
2	Symbols and Terms Used	9
3	Scope of Supply	12
4	Accessories	12
5	Technical Data	13
6	Intended Use	14
7	Warranty	15
8	Components of the Stud Welding Unit	16
8.1	Main Assemblies	16
8.2	Control Panel and Display	18
8.3	LED Display	20
9	Welding Process	21
9.1	Contact Stud Welding	21
9.2	Gap Stud Welding	23
10	Preparing Workplace and Welding Process	24
10.1	Preparing Surfaces	25
10.2	Checking the Stud Welding Gun	26
11	Connection	27
11.1	Connecting the Welding Gun to the Stud Welding Unit	28
11.2	Connecting the Ground Cable	28
11.3	Connecting the Stud Welding Unit to the Mains Supply	30

12	Welding	31
12.1	Switching on the Stud Welding Unit	31
12.2	Determining the Charging Voltage	32
12.3	Setting the Charging Voltage	35
12.4	Performing the Welding Process	35
13	Checking the Quality of the Weld	39
13.1	Carrying out Visual Inspection	39
13.2	Carrying out Bending Test	40
13.3	Optimisation of Welding Parameters	42
13.4	Blowing Effect and Remedies	43
14	Troubleshooting	44
15	Shutting Down	47
16	Maintenance and Care	48
16.1	Cleaning	48
16.2	Inspection and Tests	49
17	Storage	50
18	Disposal	50
	EC Declaration of Conformity	51
	Service & Support	52
	Index	53

1 Important Safety Precautions

The target group for this manual are qualified personnel who in view of their technical training, know-how and experience and knowledge of applicable regulations are able to assess the work assigned to them and recognise potential hazards.



Danger from incorrect use

- ◆ Use the stud welding machine only for the purpose described in this manual.

Otherwise you may endanger yourself or damage the stud welding machine.

You endanger yourself and others if you operate the stud welding machine incorrectly or fail to observe the safety precautions and warnings. This can lead to serious injury or extensive material damage.



Danger for unauthorised operating personnel

- ◆ Work with the stud welding machine only when
 - You are appropriately trained, instructed and authorised to do so, and
 - You have read and completely understood this operating manual.
- ◆ Never work with the stud welding machine when you are under the influence of
 - Alcohol,
 - Drugs or
 - Medication.



Danger from unauthorised modifications

- ◆ Never modify the stud welding machine or parts thereof without obtaining a clearance certificate from the manufacturer.

You will otherwise endanger yourself. This can lead to serious injury or extensive material damage.



Life-threatening danger for wearers of active implanted cardiac devices

- ◆ Never operate the stud welding machine if you wear a heart pace-maker or implanted defibrillator.
- ◆ In this case, never remain in the vicinity of the stud welding machine during welding.
- ◆ Never operate the stud welding machine if persons with heart pace-makers or implanted defibrillators are in the vicinity.

Strong electromagnetic fields are produced in the vicinity of the stud welding machine during welding. These fields could impact the function of heart pacemakers or implanted defibrillators.



Danger from fumes and airborne particulates

- ◆ Switch on the welding fume extractor at the place of work.
- ◆ Ensure that the room is well ventilated.
- ◆ Never weld in rooms with a ceiling height of less than 3 m.
- ◆ Observe furthermore your working instructions and the accident prevention regulations.

This will help to avoid health damage due to fumes and airborne particulates.



Danger from glowing metal spatter (fire hazard)

Glowing hot weld spatter and liquid splashes, flashes of light and a loud bang > 90 dB (A) must be anticipated during stud welding.

- ◆ Inform colleagues working in the immediate vicinity accordingly before starting work.
- ◆ Ensure that an approved fire extinguisher is available at the workplace.



- ◆ Do not weld when wearing working clothes soiled with flammable substances such as oil, grease, petroleum, etc.
- ◆ Wear your proper protective clothing, such as:
 - Protective gloves in accordance with the relevant standard,
 - Non-flammable clothing,
 - A protective apron over your clothing,
 - Full-ear hearing protection in accordance with the relevant standard,
 - A safety helmet when welding above your head,
 - Safety shoes,
 - Safety goggles with sight glass of protection level 2 in compliance with the applicable standards and do not look directly into the light arc.
- ◆ Remove all flammable materials and liquids from the vicinity of the work area before starting welding.
- ◆ Weld at a safe distance from flammable materials or liquids. Select a safety distance large enough to ensure that no danger can arise from weld spatter.



Protection of the stud welding unit

- ◆ Protect the stud welding machine against the ingress of foreign matter and liquids caused by cutting or grinding work in the vicinity of your work area.

This will help to prolong the service life of your stud welding machine.

2 Symbols and Terms Used

The symbols used in this operating manual have the following meanings:



Danger

Warns you of hazards that can lead to **injury of persons** or to **considerable material damage**.



Caution

Problems with the operating procedures **can occur** if this information is **not observed**.



No access for people with active implanted cardiac devices



Danger

Warns you of **electrical** hazards



Danger

Warns you of **electromagnetic fields** that can be generated during welding



These symbols prompt you to wear **personal protective clothing when working with the stud welding unit**.



This symbol prompts you to wear **ear protection**. **A loud bang > 90 dB (A) can occur during the welding process**.



Tip

Cross-reference to useful information on the use of the stud welding machine



Cross-references in this operating manual are marked with this symbol or *are printed in italics*



Fire hazard

Have a suitable fire extinguisher for the working area ready before starting work.



Work instruction



List

Glossary

Automatic welding head:	Device for welding of welding elements
Capacitor:	Component for storage of electrical energy.
Light arc:	Independent gas discharge between two electrodes when the current is high enough. A whitish light is emitted in the process. The light arc allows very high temperatures to be generated.
Rectifier:	Electrical component that converts alternating voltage into direct voltage
Stud feeder:	Device for automatic feeding of welding elements
Stud welding gun:	Device for welding of welding elements
Stud welding machine:	Stud welding unit including stud welding gun
Stud welding unit:	Device for provision of the electrical energy for stud welding
Thyristor:	Electronic component for contact-free switching of high currents; switching takes place via the control input
Welding element:	Component such as stud or pin that is welded to the workpiece
Welding parameters:	Mechanical and electrical settings at the stud welding gun and at the stud welding unit (e.g. spring force, charging voltage)
Workpiece:	Components such as sheet metal or tubes to which the welding elements are to be fastened

3 Scope of Supply

The **basic configuration** of your stud welding unit contains the following parts:

No. of pieces	Part	Type	Order No.
1	Stud welding unit	CDi 2302	92-10-2302B
1	Operating manual	CDi 2302	E-BA 92-10-2302B

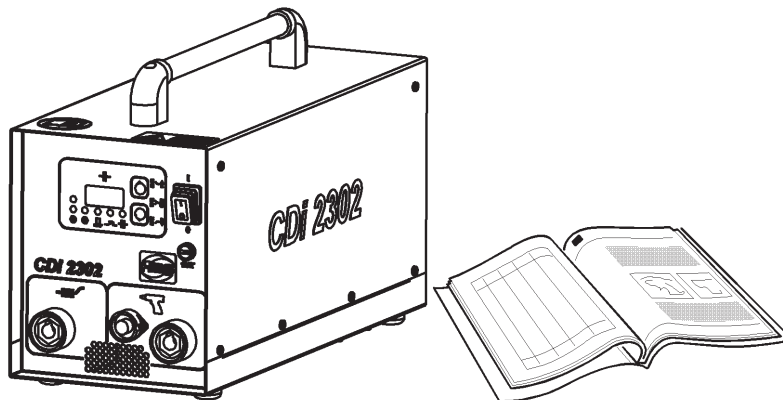

- ◆ Inspect the shipment for visible damage and completeness immediately on receipt.
- ◆ Report any transport damage or missing components immediately to the delivering shipping agent or the dealer (address, see page 2).

4 Accessories

The following ground cables are available as **accessories**:

No. of pieces	Part	Type	Order No.
1	Ground cable for	C 08/CA 08 2.5 m, 25 mm ²	92-40-095

5 Technical Data

Stud Welding Unit CDi 2302 ((with digital display)

for CD stud welding (capacitor discharge welding) according to current standards

Welding range	Studs M3 - M8, (M10 limited), dia. 2 - 8 mm, (dia. 10 mm limited)
Welding material	Mild steel, stainless steel, aluminium and brass
Welding rate	M3 = 33 studs/min. (Charging voltage 60 V) M8 = 12 studs/min. (Charging voltage 170 V) (M10 = 9 studs/min. (Charging voltage 210 V))
Capacitance	99 000 µF
Welding time	1 to 3 ms
Energy	2400 Ws
Charging voltage	50 to 220 V (stepless voltage regulation)
Primary power	230 V (pluggable to 115 V ¹⁾), 50/60 Hz, 10 AT
Power source	Capacitor
Cooling type	F (temperature controlled cooling fan)
IP Code	IP 23 (also permits operation outdoors)
Ambient temperature limits	0 °C to 40 °C
Dimension L x W x H	480 x 205 x 250 mm (without handle)
Weight	17 kg

¹⁾ Contact your service department or dealer for assistance.



6 Intended Use

Our stud welding units are designed and built exclusively for industrial use. Non-industrial use is expressly forbidden due to the lack of know-how about the welding technology employed and the applicable standards.

The stud welding unit is intended exclusively for stud welding of standardised welding elements. Any other use will result in the desired strength of the welded joint being reduced.

This stud welding unit can only be used with the HBS stud welding guns C 08 and CA 08.

The intended use also implies observance of the stud welding gun operating manual and compliance with the intervals and conditions for inspection and maintenance of the stud welding unit and the components employed.

- ◆ Always check the operating manual of your stud welding gun whether it may be used with this stud welding unit.

The stud welding unit must be suitable for welding the welding elements in use.

Welding elements manufactured with the cold formed process have a flange and an ignition tip. During welding, the flange prevents the arc getting to the cylindrical part of the welding element and increases simultaneously the welding area.



- ◆ **Please refer to the operating manual of your stud welding gun for detailed information on which welding elements may be used.**

7 Warranty

Please refer to the latest "General Terms and Conditions" for the scope of the warranty.

The warranty does not cover faults caused by e.g.

- Normal wear,
- Improper handling,
- Failure to observe the operating manual,
- Failure to observe the safety precautions,
- Use for other than the intended purpose, or
- Transport damage.

Warranty entitlement shall no longer be valid if modifications, changes or service and repair work is carried out by unauthorised persons or without the knowledge of the manufacturer. Invalidation of warranty entitlement shall also render the declaration of conformity invalid. The CE marking shall be declared invalid by the manufacturer.

We expressly point out that only spare parts and accessories or components approved by us may be used. The same applies likewise to installed units from our sub-suppliers.

8 Components of the Stud Welding Unit

8.1 Main Assemblies

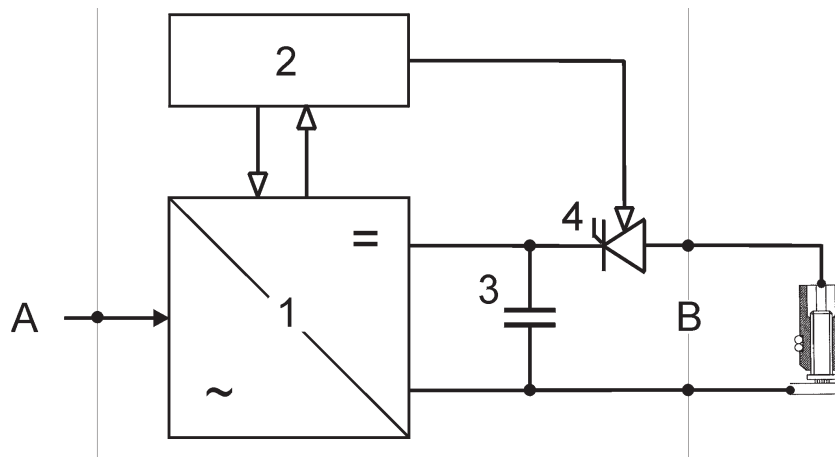

1- Charging device

A - Primary supply

2 - Control

B - Welding circuit

3 - Welding capacitors

4 - Welding thyristor

The mains alternating voltage is converted to direct voltage in the **charging device (1)**. Charging of the **welding capacitors (3)** is performed with the charging device and is fully adjustable. The welding capacitors store the energy required for the welding process. The quantity of energy is defined by the operator via the charging voltage.

The **welding thyristor (4)** releases the charging voltage.

The charging process and the welding process are controlled by the **control system (2)**.

The negative pole of the capacitor is connected to the welding gun. The positive pole is usually connected to the workpiece via vice grips.

The type plate is located on the backside of the stud welding unit.

Type plate

The type plate contains the following information:

- Manufacturer
- Type
- Order No./Serial No.
- Primary voltage
- Fuse
- Power consumption
- Cooling class
- IP code
- Date

8.2 Control Panel and Display

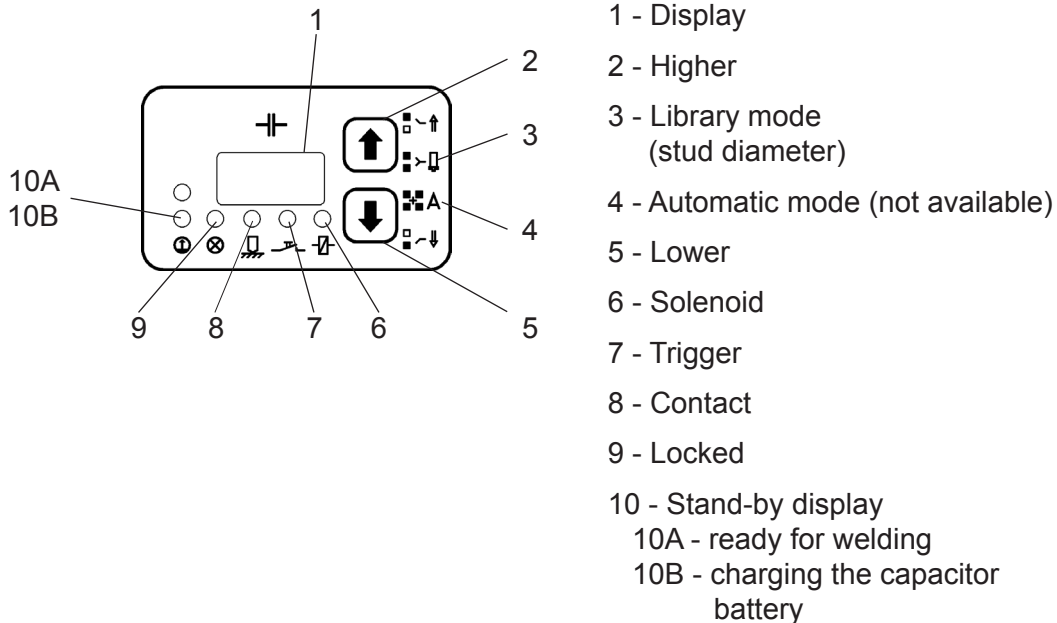

The condition of the welding unit is monitored after switching-on. The display shows three bars and the following parameters are monitored:

- Deviation from usual charging time,
- Unit temperature,
- Defective thyristor,
- Control discharge relay.

After the self-test, the charging voltage last set is shown in the display. During the self-test, an automatic self-formation of the capacitors is performed, among other things. The self-formation is a step-by-step loading of the capacitors in a certain amount of time. This function contributes to longer capacitor service life. If the charging voltage last set is above 100 V, an automatic self-formation of the capacitors is performed during the self-test. The charging voltage is shown at the **display (1)**.



The charging voltage is set with the arrow keys ( **higher (2)** -  **lower (4)**).



The stud welding unit is equipped with a **library mode (3)**. In the library mode, the factory default setting of charging voltages, depending on stud diameter can be called up and modified.

This library mode only applies to the workpiece material mild steel (suitable for welding) and the welding element material 4.8 (suitable for welding) and only when using the welding guns C 08 and CA 08.

The following values are stored in the library mode:







Material of welding elements	Diameter of welding elements metric		Charging voltage CDi 2302 in V	Welding rate in studs/min
	PT, UT	IT		
Material of workpiece: Mild steel (suitable for welding)				
4.8 (suitable for welding)	M3, 3 mm	--	60	33
4.8 (suitable for welding)	M4, 4 mm	--	80	30
4.8 (suitable for welding)	M5, 5 mm	5 mm, M3	100	24
4.8 (suitable for welding)	M6, 6 mm	6 mm, M4	130	17
4.8 (suitable for welding)	M8, 7.1 mm	7.1 mm, M5	170	12
4.8 (suitable for welding)	M10, 10 mm	--	220	9

If both arrow keys ( ) are simultaneously pressed for about one second, the display shows **0. .3.** (3 means the charging voltage for stud diameter M3).

The stud diameter (M3 to M10) can be pre-selected with both arrow keys ( higher -  lower). After about 5 seconds the display jumps onto the pre-selected charging voltage. The capacitor battery is charged with this value.

In addition, the charging voltage can be modified individually by pressing the arrow key.

8.3 LED Display

	Green	The stud welding unit is ready for welding
	Red	The capacitor battery is charged.
	Red	The stud welding unit is locked <ul style="list-style-type: none">– after welding, until there is electrical contact with the workpiece– if the stud welding unit is overheated. After a short cooling period, the work can be continued.– if thyristor is defective– in the case of a charging malfunction (exceeding the charging period)– if arrow keys jam– when appealing the library mode (stud diameter)
	Yellow	if there is electrical contact between welding element and workpiece
	Yellow	if the welding gun button is triggered
	Yellow	if a welding gun with solenoid is connected

If one of the parameters referred to under *point 8.2 “Keyboard and Display”* deviates from the standard value an error message will be shown on the display.

9 Welding Process

Stud welding with tip ignition is divided into contact stud welding and gap stud welding. This stud welding unit must be used exclusively for stud welding with contact and gap.

9.1 Contact Stud Welding

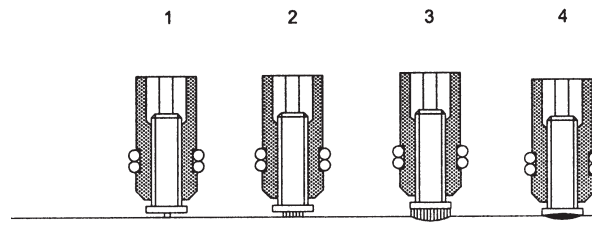

- The stud welding gun is placed onto the workpiece (see figure, **position 1**). The welding element which projects above the welding gun support legs, is pushed back tensioning a pressure spring.
- After positioning the stud welding gun against the workpiece, the operator presses the welding gun trigger and starts the welding process; thus the current circuit is closed.
- The capacitors of the stud welding unit are discharged. Because of the high discharge current, the ignition tip evaporates explosion-like. The air gap between welding element and workpiece is ionized (see figure, **position 2**), an arc is produced.
- The light arc melts the face of the welding element together with an area of the workpiece of about the same dimension (see figure, **position 3**).
- Caused by the pressure spring, the welding element moves to the workpiece with a speed of 0,5 to 1 m/s. The adjusted spring force controls the plunging speed of the welding element.
- Higher plunging speed leads to shortened arc time and consequently to lower welding energy with identical voltage setting.
- The light arc is cut as soon as the welding element touches the workpiece.
- Now the capacitors are short-circuited and the rest of the energy drains off (see figure, **position 4**).
- The pressure spring continues to push the welding element into the weld pool.



-
- The weld pool solidifies and the welding element is physically connected to the workpiece.
 - The time period between ignition of the arc and solidification of the weld pool is about 3 ms.
 - The use of contact welding for rapidly oxidising materials like aluminium and aluminium alloys is not recommended because the arcing period with contact welding is longer than with gap stud welding.

9.2 Gap Stud Welding

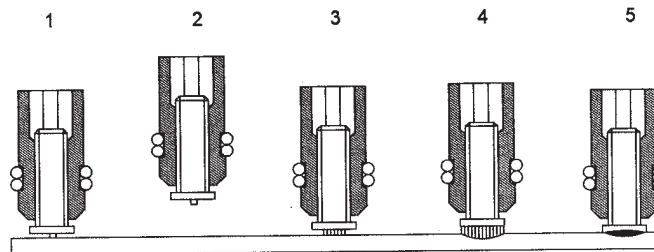

- The solenoid, which is integrated into the welding gun, lifts the welding element from the workpiece (see figure, **position 1**) to the adjusted value "lift" above the workpiece and tensions a pressure spring (see figure, **position 2**).
- As soon as the welding piston has reached the upper stop, the current to the solenoid is cut. Simultaneously, the welding thyristor is triggered and releases the current flow to the welding element.
- The capacitors of the stud welding unit are discharged. Because of the high discharge current, the ignition tip evaporates explosion-like. The air gap between welding element and workpiece is ionized (see figure, **position 3**). An arc is produced.
- The light arc melts the face of the welding element together with an area of the workpiece of about the same dimension (see figure, position 4).
- The welding element is moved by the pressure spring to the workpiece with a speed of 0.5 to 1.5 m/s. The adjusted spring force and the preset lift distance controls the plunging speed of the welding element.
- Higher plunging speed leads to shortened arc time and consequently to lower welding energy with identical voltage setting.
- The arc is cut as soon as the welding element touches the workpiece.
- Now the capacitors are short-circuited and the rest of the energy drains off (see figure, **position 5**).
- The pressure spring continues to push the welding element into the weld pool.
- The weld pool solidifies and the welding element is physically connected to the workpiece.
- The time period between ignition of the arc and solidification of the weld pool is about 1 to 2 ms.

10 Preparing Workplace and Welding Process



Danger from fumes and airborne particulates

- ◆ Switch on the welding fume extractor at the workplace.
- ◆ Ensure that the room is well ventilated.
- ◆ Never weld in rooms with a ceiling height of less than 3 m.
- ◆ Observe furthermore your working instructions and the accident prevention regulations.

This will help to avoid health damage due to fumes and airborne particulates.



Danger from fire and explosion

- ◆ Remove all inflammable materials and liquids from your working area.
- ◆ Ensure that there are no explosive materials in your working area.
- ◆ Ensure that an approved fire extinguisher is available at the workplace.



Danger from tripping and falling

- ◆ Lay cables and connecting leads in such a way that they are protected against damage and
- ◆ that you or third parties cannot trip over them or fall.



Warning of weld spatter

- ◆ Ensure that there is no equipment or apparatus in the working area that could be damaged by weld spatter.
- ◆ Remove if necessary.



Warning of electromagnetic fields

- ◆ Ensure that there is no equipment or apparatus in the working area that could be damaged by magnetic fields.
- ◆ Remove if necessary.



Danger!

- ◆ Ensure that there is a free circulation of air through the housing of the stud welding unit.
- ◆ Always place the stud welding unit on a stable, level and clean surface.
- ◆ Check the condition of all cables and cable connections.
- ◆ Have defective cables or their connections immediately repaired or replaced by a qualified electrician.

10.1 Preparing Surfaces

- ◆ Remove
 - Paint, oil and other impurities,
 - Rust,
 - Non-conductive coatings (of surface-coated materials)

from the welding surface and the contact points of the ground clamps.

This ensures a high strength of the welded joints.

- ◆ **Weld the welding element only to a flat surface.**
- ◆ Ask your application consultant at HBS about welded joints on tubes and ruffle plates (*see page 2*).

10.2 Checking the Stud Welding Gun

- ◆ Always check the operating manual of your stud welding gun to see whether it may be used with this stud welding unit.

This stud welding unit can only be used with the HBS welding guns C 08 and CA 08.

- ◆ Check the chuck of your stud welding gun for proper fit and ensure it is tightened.
- ◆ Check the bellows of your stud welding gun for damage.
- ◆ Check if spring force and lift are set according to the welding parameter table in the operating manual of the stud welding gun.



- ◆ **Refer here to the operating manual of your stud welding gun.**

11 Connection



◆ **First prepare your workplace.**

- ◆ Read and observe here *point 10 "Preparing Workplace and Welding Process"*.



Electric shock hazard

- ◆ Leave the stud welding unit switched off during connection of the connecting leads.

In this way you can avoid any unintentional starting of the welding process.



◆ **Secure the cables.**

Strong magnetic fields are generated during the welding process that can lead to whipping of the cables. This can cause the cables to come out of the plug sockets.

11.1 Connecting the Welding Gun to the Stud Welding Unit

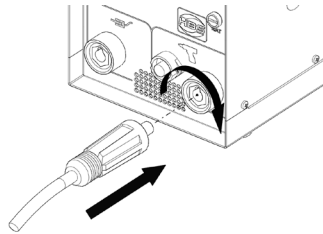

Connect the welding current cable

- ◆ Only now plug the welding current cable into the corresponding socket of the stud welding unit.
- ◆ Press in the plug and turn it firmly clockwise (to the right).

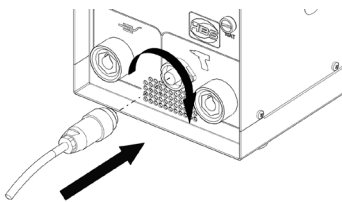

Connect the control cable

- ◆ Plug the control cable into the corresponding socket of the stud welding unit.
- ◆ Twist the retaining nut of the control cable connector clockwise.



Only loosely made connections will result in damage to the plug connectors.

- ◆ Therefore always check that the plug connector is firmly inserted.
This prevents a poor contact and hence overheating of the plug connectors.

11.2 Connecting the Ground Cable

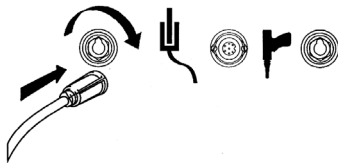

Connect the ground cable

- ◆ Plug the ground cable into the corresponding socket of the stud welding unit.
- ◆ Press in the plug and turn it firmly clockwise (to the right).



Only loosely made connections will result in damage to the plug connectors.

- ◆ Therefore always check that the plug connector is firmly inserted.

This prevents a poor contact and hence overheating of the plug connectors.

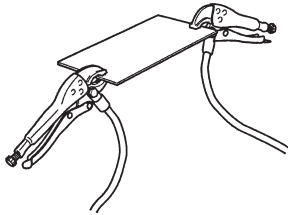

Connect the ground clamps

- ◆ Remove rust, paint and dirt from the points on the workpiece to which you wish to connect the ground clamps.
- ◆ Attach the ground clamps to the workpiece as tightly as possible.
- ◆ Pay attention to a good contact and symmetrical connection.



The welding point should be in the middle between the two ground clamps.

11.3 Connecting the Stud Welding Unit to the Mains Supply



Electric shock hazard

- ◆ Have an electrician check whether the plug socket to which you intended to connect the stud welding unit is correctly earthed.
- ◆ Connect the stud welding unit only to a mains supply with the same mains voltage as that indicated on the type plate.
- ◆ Compare the current consumption indicated on the type plate with the fuse of your mains power supply.
- ◆ Check that the stud welding unit is switched off.
- ◆ Only now insert the plug into the plug socket.

12 Welding



- ◆ **First connect up the stud welding unit.**
- ◆ Read and observe here *point 11 „Connection“*.



Danger for wearers of heart pacemakers

- ◆ Never operate the stud welding unit if you have a heart pacemaker.
- ◆ In this case, never remain in the vicinity of the stud welding unit during welding.
- ◆ Never operate the stud welding unit if persons with heart pacemakers are in the vicinity.

Strong electromagnetic fields are produced in the vicinity of the stud welding unit during welding. These fields may impair the function of the heart pacemakers.

12.1 Switching on the Stud Welding Unit

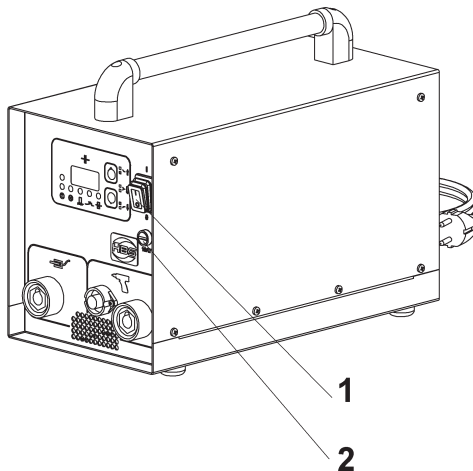

- 1 - Mains switch
- 2 - Mains fuse

- ◆ Only now switch on the stud welding unit at the **mains switch (1)**.

12.2 Determining the Charging Voltage

Determination of charging voltage at the stud welding unit using the arrow keys depends i.a. on

- the stud welding gun used,
 - the material of the welding element,
 - the diameter of the welding element,
 - the material of the workpiece.
- ◆ Determine the charging voltage to be set at the stud welding unit using the following tables.



The figures in these table are indicative values and must be checked by means of a test welding on the original material with the same properties as the original workpiece.

Determining the Charging Voltage for the Welding Guns C 08 and CA 08

Material of welding elements	Diameter of welding elements metric		Charging voltage ¹⁾ CDi 2302 in V	Welding rate ⁴⁾ in studs/min
	PT, UT	IT		
Material of workpiece: Mild steel (suitable for welding)				
4.8 (suitable for welding)	M3, 3 mm	--	60	33
4.8 (suitable for welding)	M4, 4 mm	--	80	30
4.8 (suitable for welding)	M5, 5 mm	5 mm, M3	100	24
4.8 (suitable for welding)	M6, 6 mm	6 mm, M4	130	17
4.8 (suitable for welding)	M8, 7.1 mm	7.1 mm, M5	170	12
4.8 (suitable for welding)	M10, 10 mm ⁶⁾	⁶⁾	220 ^{2) 6)}	9
Material of workpiece: Galvanised steel (suitable for welding)				
4.8 (suitable for welding)	M3, 3 mm	--	80	30
4.8 (suitable for welding)	M4, 4 mm	--	120	18
4.8 (suitable for welding)	M5, 5 mm	5 mm, M3	170	12
4.8 (suitable for welding)	M6, 6 mm	6 mm, M4	210	9
4.8 (suitable for welding)	M8, 7.1 mm	7.1 mm, M5	--	--
4.8 (suitable for welding)	M10, 10 mm ⁶⁾	⁶⁾	--	--
Material of workpiece: Alloyed steel (suitable for welding)				
A2-50	M3, 3 mm	--	60	33
A2-50	M4, 4 mm	--	70	31
A2-50	M5, 5 mm	5 mm, M3	90	26
A2-50	M6, 6 mm	6 mm, M4	130	17
A2-50	M8, 7.1 mm	7.1 mm, M5	170	12
A2-50	M10, 10 mm ⁶⁾	⁶⁾	210 ^{2) 6)}	9
Material of workpiece: Alloyed steel (suitable for welding)				
CuZn37	M3, 3 mm	--	60	33
CuZn37	M4, 4 mm	--	70	31
CuZn37	M5, 5 mm	5 mm, M3	100	24
CuZn37	M6, 6 mm	6 mm, M4	150	14
CuZn37	M8, 7.1 mm	7.1 mm, M5	220	9
CuZn37	M10, 10 mm ⁶⁾	⁶⁾	--	--
Material of workpiece: Aluminium				
AlMg3	M3, 3 mm	--	60	33
AlMg3	M4, 4 mm	--	80	30
AlMg3	M5, 5 mm	5 mm, M3	100	24
AlMg3 ⁵⁾	M6, 6 mm	6 mm, M4	140 ³⁾	15
AlMg3 ⁵⁾	M8, 7.1 mm ⁵⁾	7.1 mm, M5 ⁵⁾	--	--
AlMg3 ⁵⁾	M10, 10 mm ^{5) 6)}	^{5) 6)}	--	--

¹⁾ to be checked by test weldings

²⁾ only in combination with welding gun C 08 possible

³⁾ only in combination with welding gun CA 08 possible

⁴⁾ ambient temperature: 20 °C

⁵⁾ Due to the material characteristics of Aluminium and the corresponding limitations regarding the process stability a maximum stud diameter of 6 mm is recommended.

⁶⁾ Welding element is not standardized according to DIN EN ISO 13918, but manufactured by the manufacturer's discretion. The welding parameters should be determined by test weldings.

Bi-Metallic pins²⁾

Material of welding elements	Diameter bush metric in mm	Charging voltage ¹⁾ CDi 2302 in V
Material of workpiece: Aluminium		
AlMg3	6	160

¹⁾ to be checked by test welds

²⁾ **only** in combination with welding gun CA 08 possible

12.3 Setting the Charging Voltage



- ◆ **First determine the necessary charging voltage.**
- ◆ Read and observe here *Point 12.2 „Determining the Charging Voltage“*.



- ◆ Only now set the necessary charging voltage with the arrow buttons.



12.4 Performing the Welding Process



- ◆ **First set the necessary charging voltage.**
- ◆ Read and observe here *Point 12.3 „Setting the Charging Voltage“*.



Electric shock and light arc hazard

- ◆ Never touch the welding elements, chuck, retaining nut or electrically conductive parts in their vicinity during the welding process.

These parts are live.

- ◆ Never wear metal jewellery, even a wristwatch, on your body during the welding process.

This will help to avoid injuries and damage due to electric power or electromagnetic fields.



Electric shock and light arc hazard

- ◆ Stand on an insulated mat if you have to weld under the following conditions:
 - In confined spaces with electrically conductive walls
 - Under cramped conditions between or against electrically conductive parts
 - Where there is limited mobility on electrically conductive parts
 - In damp, wet or hot rooms.

**Danger of deflagration of explosive gases and substances**

- ◆ Never weld in rooms with an explosion hazard.
- ◆ Never weld on vessels containing or that have contained substances
 - which are inflammable or promote combustion,
 - which may create health-endangering gases, fumes or airborne particulates,
 - or which could cause explosions.

Such work may only be carried out by welding specialists.

- ◆ Do not carry out such work if you have not been specially trained for it.

**Risk of fire and burns due to glowing weld spatter**

- ◆ Wear your personal protective equipment and
- ◆ your safety goggles with sight glass of protection class 2.
- ◆ Wear a protective helmet when welding over head.
- ◆ Remove all inflammable materials and liquids from the vicinity of the place of work before starting welding.
- ◆ Ensure that an approved fire extinguisher is available at the place of work.
- ◆ Observe furthermore your working instructions and the accident prevention regulations.

Glowing hot weld and liquid spatter occur during welding.

**Danger due to noise**

- ◆ Wear your ear protection during welding.
- ◆ Observe furthermore your working instructions and the accident prevention regulations.
- ◆ Inform colleagues working in the immediate vicinity accordingly before starting work.

A > 90 dB (A) bang can occur during the welding process.



- ◆ Ensure that the welding gun has been prepared in accordance with the corresponding operating manual.

- ◆ Check whether a welding element has been inserted into the welding gun.
- ◆ Insert a welding element, if necessary.
- ◆ Place the welding gun perpendicularly onto the workpiece as soon as the stud welding unit is ready for the welding process.
- ◆ Press the welding gun firmly with both hands against the workpiece until the welding gun attachment (spacer) is resting uniformly on the workpiece.
- ◆ Hold the welding gun firmly, steady and straight.
- ◆ Ensure that you do not touch any metal parts of the welding gun.
- ◆ Only now should you press the button of the welding gun.

The welding process is started.



- ◆ **Always pull the welding gun perpendicularly away from the welding element after the welding process.**

If you pull the welding gun away at an angle, you will strain the chuck and shorten its service life.

**Risk of burns**

The gun head becomes very hot during the welding process. The same applies to the welded element and the workpiece.

- ◆ Wear your proper protective clothing.



- ◆ **Use only welding elements of one batch.**
- ◆ Pay strict attention not to mix welding elements from different batches.
- ◆ Carry out test welds again after a batch change.

Even the slightest changes to the geometry, in particular to the tip of the welding elements require different settings for the welding process.



- ◆ Now check the quality of the welded joint before inserting a new welding element and repeating the welding process.
- ◆ Work in accordance with the following *point 13*.

13 Checking the Quality of the Weld

You can check the quality of the weld by means of a visual inspection and a bending test.

The number and type or method of the tests to be performed and the acceptance criteria are defined in respective standards for quality demands.

13.1 Carrying out Visual Inspection

- ◆ Carry out a visual inspection on all welding elements.

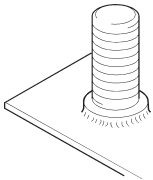
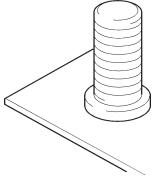
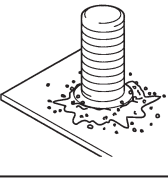
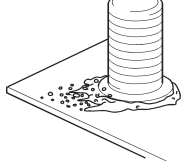
Visual Inspection		
Condition	Possible cause	Corrective actions
 <p>Good welded joint Low spatters around the weld without outer flaws The weld pool forms a collar around the flange of about 1 - 1.5 mm</p>	Correct parameters	none
 <p>Gap between flange and workpiece</p>	<p>Weld energy too low</p> <p>Plunging speed too low</p> <p>Insufficient support of parent material</p>	<p>Increase weld energy</p> <p>Correct plunging speed</p> <p>Provide support</p>
 <p>Many spatters around the weld</p>	<p>Weld energy too high</p> <p>Insufficient plunging speed</p>	<p>Reduce weld energy</p> <p>Increase plunging speed</p>
 <p>One-sided weld pool One-sided spatter collar Weld pool came out on one side</p>	<p>Effect of arc blow</p> <p>Unsymmetric ground connection</p> <p>Welding gun put at an angle</p>	<p>Take care for symmetrical ground connection</p> <p>Put welding gun vertically to the workpiece</p>

13.2 Carrying out Bending Test

You can purchase from HBS a bending device with inserts for various diameters of the welding elements.

The bending test serves as an easy work sample and as a check for the selected welding parameters. The welded joint is stressed by bending in a non-defined way.

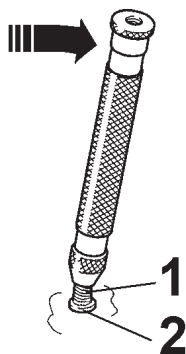

1 - Welding element

2 - Welded joint

◆ Place the bending device on the **welding element (1)** and

◆ bend the **welding element (1)** with the bending device once by 30° in any direction.

The bending test is passed if a crack or a fracture of the welded zone does not occur.

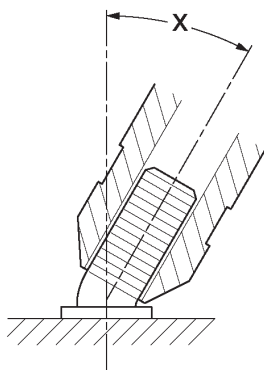

◆ **Further tests should be conducted if the connection fails in the weld area.**

◆ In this case, **bend** the welding element exactly in the opposite direction by 30° towards the failing seam.



◆ You don't need to test all studs.

It is sufficient to carry out stud tests on several production samples that are picked at random.

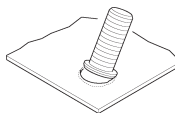
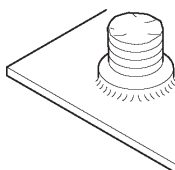
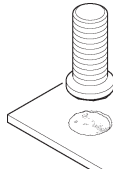
Bending Test		
Type of fracture	Possible cause	Corrective actions
 <p>Base material buckling</p>	Correct parameters	none
 <p>Fracture in welding element above flange</p>	Correct parameters	none
 <p>Fracture in the weld metal</p>	<p>Weld energy too low</p> <p>Plunging speed too low</p> <p>Unsuitable stud/base material combination</p>	<p>Increase weld energy</p> <p>Increase plunging speed</p> <p>Replace welding element or workpiece</p>

If the strength of the joint is inadequate, then:

- ◆ check the setting of the stud welding unit.
- ◆ check whether the surface of welding element and base material are clean and electrically conductive.

They must be free from scale, oil, paint, oxide layers.

- ◆ Grind off hardened workpiece surfaces (e.g. roll hardening).
- ◆ Check the piston of the welding gun for ease of movement.

13.3 Optimisation of Welding Parameters



- ◆ **As first step, conduct the tests outlined under points 13.1 and 13.2.**
- ◆ **As second step optimise the welding parameters according to the table under *point 12.2 Determining the Charging Voltage*.**
- ◆ **Optimise the welding parameters of the stud welding unit.**
- ◆ **Check the settings of the welding gun.**
- ◆ **If necessary re-adjust the lift and spring pressure.**



- ◆ **Refer here to the operating manual of your welding gun.**

13.4 Blowing Effect and Remedies

With asymmetric ground connections, different material distributions or when welding at the edge of a workpiece a "blowing effect" can occur. This is an undesirable deflection of the light arc. This results in uneven melting of the stud material, in increased poring and undercuts in the welding area.

The blowing effect is proportional to the current amperage and can be influenced by symmetrical connection of the ground terminals, by connecting compensating grounds or (on welding guns with external welding cable) by turning the welding gun about its vertical axis.

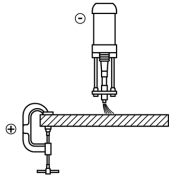
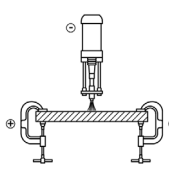
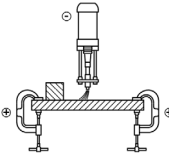
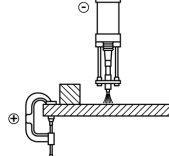
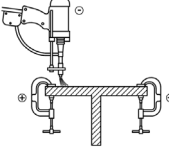
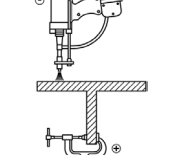

Blowing effect	
Cause	Remedy
	
	
	

14 Troubleshooting



Danger from insufficiently qualified operating personnel

- ◆ Carry out only the work described here on your stud welding unit or stud welding gun.
- ◆ Repairs may only be carried out by appropriately qualified personnel.
- ◆ Inform your dealer or your maintenance department.

Fault	Possible cause	Fault localisation	Fault remedy	Performance
Light signal of primary switch does not light	Primary outlet defective	Check primary outlet *)	Replace primary outlet*)	Qualified specialists
	Mains cable broken	Check mains cable*)	Replace mains cable*)	Qualified specialists
No LED display at the front	Fuse F4 10 AT defective	Check mains fuse*)	Replace mains fuse F4 on the front plate of the stud welding unit*)	Qualified specialists
	Leads interrupted	Check leads*)	Replace leads*)	Qualified specialists
No  display	No ground connection	Check ground connection on workpiece	Tighten ground connection properly	Trained personnel
	Gun not connected	Check gun connection	Connect gun properly	Trained personnel
	Transition resistance (between stud and workpiece) too high	Check material surface	Clean or grind material surface	Trained personnel
	Ground cable broken	Check ground cable*)	Replace ground cable*)	Qualified specialists
	Welding gun cable broken	Check welding gun cable*)	Replace welding gun cable*)	Qualified specialists
No  display	Defective connecting line of welding gun	Check function of connecting line*)	Replace connecting line*)	Qualified specialists
	Welding gun trigger button defective	Check control cable for electrical flow with triggered start button*)	Replace welding gun trigger button*)	Qualified specialists
	Control cable broken	Check control cable for electrical flow*)	Replace control cable*)	Qualified specialists

Fault	Possible cause	Fault localisation	Fault remedy	Performance
Continuously red display: Er ⊗	Discharge relay control unable	Switch off stud welding unit; then switch on after some seconds; if the stud welding unit is still locked, switch off the stud welding unit - inform the responsible service department	If no mentioned actions are successful, please contact our service department	Trained personnel
Continuously red display: E t ⊗	Discharge transistor defective	Switch off stud welding unit; then switch on after some seconds; if the stud welding unit is still locked, switch off the stud welding unit - inform the responsible service department	If no mentioned actions are successful, please contact our service department	Trained personnel
Continuously red display: Elt ⊗	Charging time of capacitor battery too long	Switch off stud welding unit; then switch on after some seconds; if the stud welding unit is still locked, switch off the stud welding unit - inform the responsible service department	If no mentioned actions are successful, please contact our service department	Trained personnel
Continuously red display: EtY ⊗	Main thyristor or control defective	Switch off stud welding unit; then switch on after some seconds; if the stud welding unit is still locked, switch off the stud welding unit - inform the responsible service department	If no mentioned actions are successful, please contact our service department	Trained personnel
Continuously red display: hot ⊗	Charging error	Wait with switched on stud welding unit until the p.c. board charge control has cooled down. If the stud welding unit then still displays hot , inform the responsible service department	If no mentioned actions are successful, please contact our service department	Trained personnel



Fault	Possible cause	Fault localisation	Fault remedy	Performance
Continuously red display: EtA	Arrow keys sticking	Check arrow keys	Press arrow keys	Trained personnel
Continuously red display: EtP	Device temperature too fast	Let switched on stud welding unit cool down	Stud welding unit resets automatically	Trained personnel
Gun does not lift, in spite of and	No lift adjusted	Check settings of welding gun	Modify set parameters	Trained personnel
	Short circuit of solenoid circuit of the gun	Check resistance value at control cable connector (18 Ω to 22 Ω) between Pin 1 and Pin 2*)	Replace control cable-connector, control cable and solenoid*)	Qualified specialists
	Solenoid defective	Check solenoid (18 Ω to 22 Ω*)	Replace solenoid*)	Qualified specialists
No display	Magnetic circuit interrupted	Check resistance value at control cable connector (18 Ω to 22 Ω) between Pin 1 and Pin 2*)	Replace solenoid or control cable*)	Qualified specialists



Work marked with *) may only be carried out by qualified electricians!

- ◆ Please contact our Service department if none of the measures described remedies the situation.
- ◆ Please use the form „Service & Support“ in the annex to send in the stud welding unit.

15 Shutting Down

- ◆ Switch off the stud welding unit.
- ◆ Pull out the mains plug.
- ◆ Disconnect the control cable and welding cables from the stud welding unit.
- ◆ Protect the stud welding unit and its components against the ingress of liquids and foreign matter.

16 Maintenance and Care



Electric shock hazard

- ◆ Always switch off the stud welding unit before starting maintenance and care work.
- ◆ Pull out the mains plug.



Danger from insufficiently qualified operating personnel

- ◆ Carry out only the work described here on your stud welding unit.
- ◆ Repairs may only be carried out by appropriately qualified personnel.
- ◆ Inform your dealer or your maintenance department.

16.1 Cleaning

- ◆ Clean the surface of the stud welding unit with a slightly damp cloth, when necessary.
- ◆ Add a little household detergent to the cleaning water.



◆ Do not use solvents for cleaning.

These can damage the surface of your stud welding unit.



The inside of the stud welding unit must be cleaned at least every three months.

- ◆ Inform your dealer or your maintenance department.

16.2 Inspection and Tests



- ◆ **Inspect the condition of the mains cable.**
- ◆ Inform your dealer or maintenance department if you discover any damage.
- ◆ Check whether the readings on the display of the stud welding unit are still legible before starting work.
- ◆ Clean display and control panel in the event of soiling.
- ◆ Replace any removed or damaged signs:



Before opening machine disconnect mains



Observe the operating manual



Warning of electric shock hazard

17 Storage

- ◆ Store the stud welding unit in a safe and dust-free location when not in use.
- ◆ Protect the stud welding unit from moisture and metallic contamination.



- ◆ Store the stud welding unit only under the following ambient conditions.

Storage temperature:

-5 °C to +50 °C

Relative humidity:

0 % - 50 % at +40 °C

0 % - 90 % at +20 °C

18 Disposal

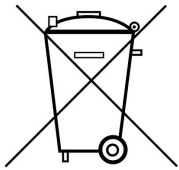

- ◆ Dispose of the stud welding unit only via the manufacturer or a specialist disposal company.
- ◆ Never dispose of the stud welding unit in the domestic refuse.

EC Declaration of Conformity

in Accordance with Directive 2006/42/EC, Annex II 1 A
(Original EC Declaration of Conformity)

Herewith the manufacturer

HBS Bolzenschweiss-Systeme GmbH & Co. KG
Felix-Wankel-Strasse 18
P.O. Box 13 46
85221 Dachau
GERMANY
Phone +49 8131 511-0
Fax +49 8131 511-100

declares for the following product

Machine information: Stud welding unit
Type: CDi 2302
Order No: 92-10-2302B
Serial No: 92-10-2302B/181XXXX
Year of manufacture: 2018

in conjunction with HBS components

that the machinery fulfils all the relevant provisions to this Directive, including changes to the Directive to be applied at the moment of this declaration.

The product is conform with following further EU Directives, including changes to the Directives to be applied at the moment of this declaration:

„Low voltage guideline“ 2014/35/EU
„EMC guideline“ 2014/30/EU
„Directive on the restriction of the use of certain hazardous substances in electrical and electronic equipment“ 2011/65/EU

Following harmonised standards (or parts thereof) were applied:

DIN EN 60974-1 Arc welding equipment - Part 1:
Welding power sources
DIN EN 60974-10 Arc welding equipment - Part 10:
Product standard for arc welding equipment
DIN EN 60204-1 Safety of machinery - Electrical equipment of machines;
Part 1: General requirements

The following national standards and other specifications (or parts thereof) were applied:

VDE 0544-1

Persons who are based in the European community and who are authorised to compile the technical documentation:

Name: Heike Otto Address: see manufacturer

Dachau, 02.01.2018

Place of issue, Date



Gregor Gröger (General Manager HBS)



Service & Support

With the return please attach a copy of the filled out form together with the repair number given by HBS! Repairs without repair number will not be processed.

Repair number
(given by HBS)

Company: _____
 Name / Surname: _____
 Street: _____
 City, State and ZIP/Postcode: _____
 Country: _____
 Phone & Fax: _____
 E-mail address: _____

Stud welding unit / stud welding gun
 type of model: _____
 Serial number: _____
 Date of purchase: _____
 Purchased at distributor: _____

Detailed descriptions of errors: _____

Service & Support may be done up to the value of EUR _____ without quotation: Yes No

Could you find any damage / burn marks on the cables: Yes No

on chucks: Yes No

Are all plug and screw connections tightly fastened *: Yes No

Are there any burn marks on plug or screw connections: Yes No

Is there any other visual damage (e.g. cracks, dents): Yes No

Have you checked the fuses: Yes No

Default on the display of the stud welding unit:

ARC / IT					CD / CDM / SC						

Which LED's are illuminated (please mark with a cross)?

Please e-mail or fax this form to service@hbs-info.de or fax: +49 8131 511-100.
 In case a repair is necessary a repair number will be given!

* See also operating manual chapter „Connection“
 ** Doesn't light when using a contact welding gun

Index

A

accessories 12
airborne particulates 7, 24
arrow keys 18
automatic welding head 11

B

bang 7, 37
basic configuration 12
batch 38
bending device with inserts 40
bending test 40
blowing effect 43

C

capacitor 11, 21, 23
charging device 16
charging voltage 18, 33
checking the quality 39
cleaning 48
clothing, non-flammable 8
contact stud welding 21
control 16
control cable 28
control panel and display 18

D

danger from incorrect use 6
determination of charging voltage 32
disposal 50

E

ear protection 9
electrical hazards 9
electromagnetic fields 9, 31

F

fire extinguisher 7, 36
fire extinguisher, approved 24
fire hazard 7
form „Service & Support“ 46, 52
full-ear hearing protection 8
fumes, harmful to health 7, 24
fuse 30

G

gap stud welding 22, 23
glossary 11

goggles with visor 8
ground cable 28
ground clamps 29

H

hazards for the machine 9
hazards for the operator 9
heart pacemaker 7, 9, 31
helmet 8

I

ignition tip 21, 23
intended use 14, 26

L

LED display 20
lift 23
light arc 11, 21, 23
liquids, inflammable 24

M

main assemblies 16
mains power supply 30
mains voltage 30
maintenance and care 48
maintenance and care, regular 48
materials, inflammable 24

O

operating manual 12
oxidizing materials 22

P

plunging speed 21
protective apron 8
protective equipment 8
protective equipment, personal 9
protective gloves 8

R

rectifier 11
risk of burns 36
risk of falling 24
risk of fire 36
risk of tripping 24

S

safety goggles 9
safety goggles with sight glass 8



safety precautions 6
 scope of supply 12
 setting the charging voltage. 35
 shutting down 47
 spacer 37
 speed. 23
 storage. 50
 storage temperature 50
 stud feeder. 11
 stud welding gun 11
 stud welding machine 11
 stud welding unit 11
 substances, explosive 24
 surface of base material 41
 surface of welding element 41
 switch on the stud welding unit 31
 symbols used. 9

T

test welding 32
 troubleshooting 44
 type plate. 17, 30

V

vessels, welding work on. 36
 visual inspection 39

W

warranty entitlement 15
 welding capacitors. 16
 welding current cable. 28
 welding element. 11
 welding energy 21, 23
 welding gun attachment. 37
 welding parameters. 11, 26
 welding process. 21
 welding thyristor. 16
 workpiece 11

HBS Bolzenschweiss-Systeme GmbH & Co. KG
Felix-Wankel-Strasse 18 • 85221 DACHAU • GERMANY
Phone +49 8131 511-0 • Fax +49 8131 511-100 • E-mail international@hbs-info.com

www.hbs-info.com